

# Light 15

Mounting instruction

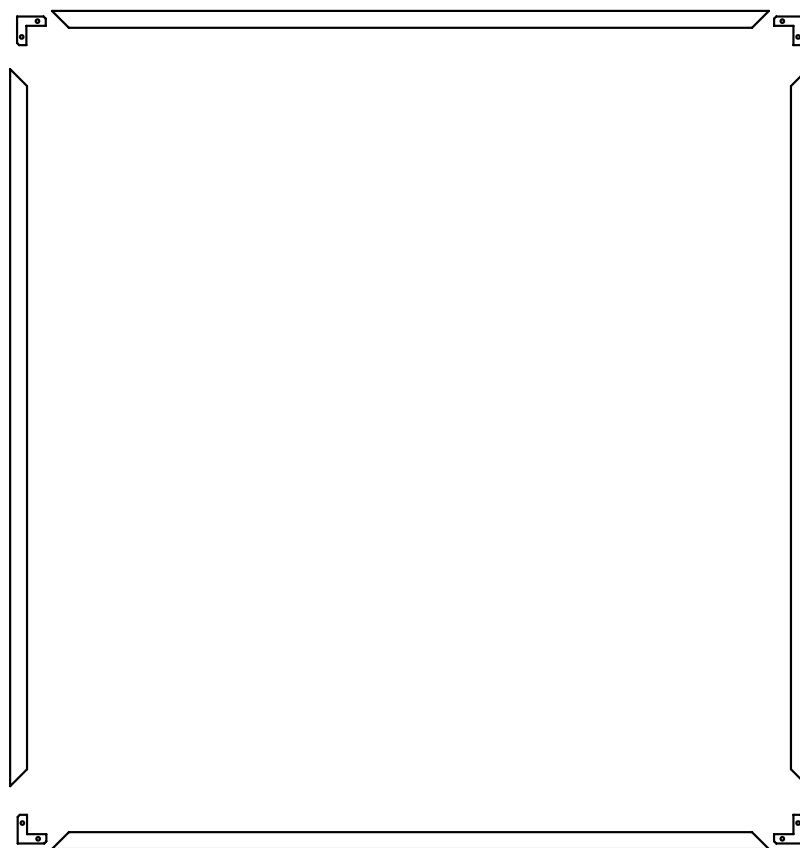

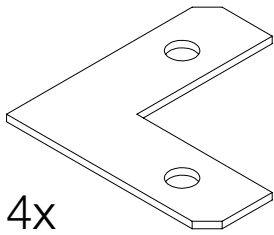

4x  
cornerlock

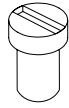

4x  
cornerlock screw

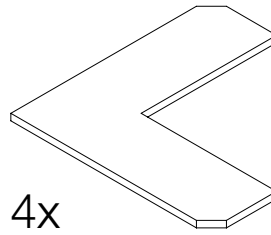

4x  
blind cornerlock

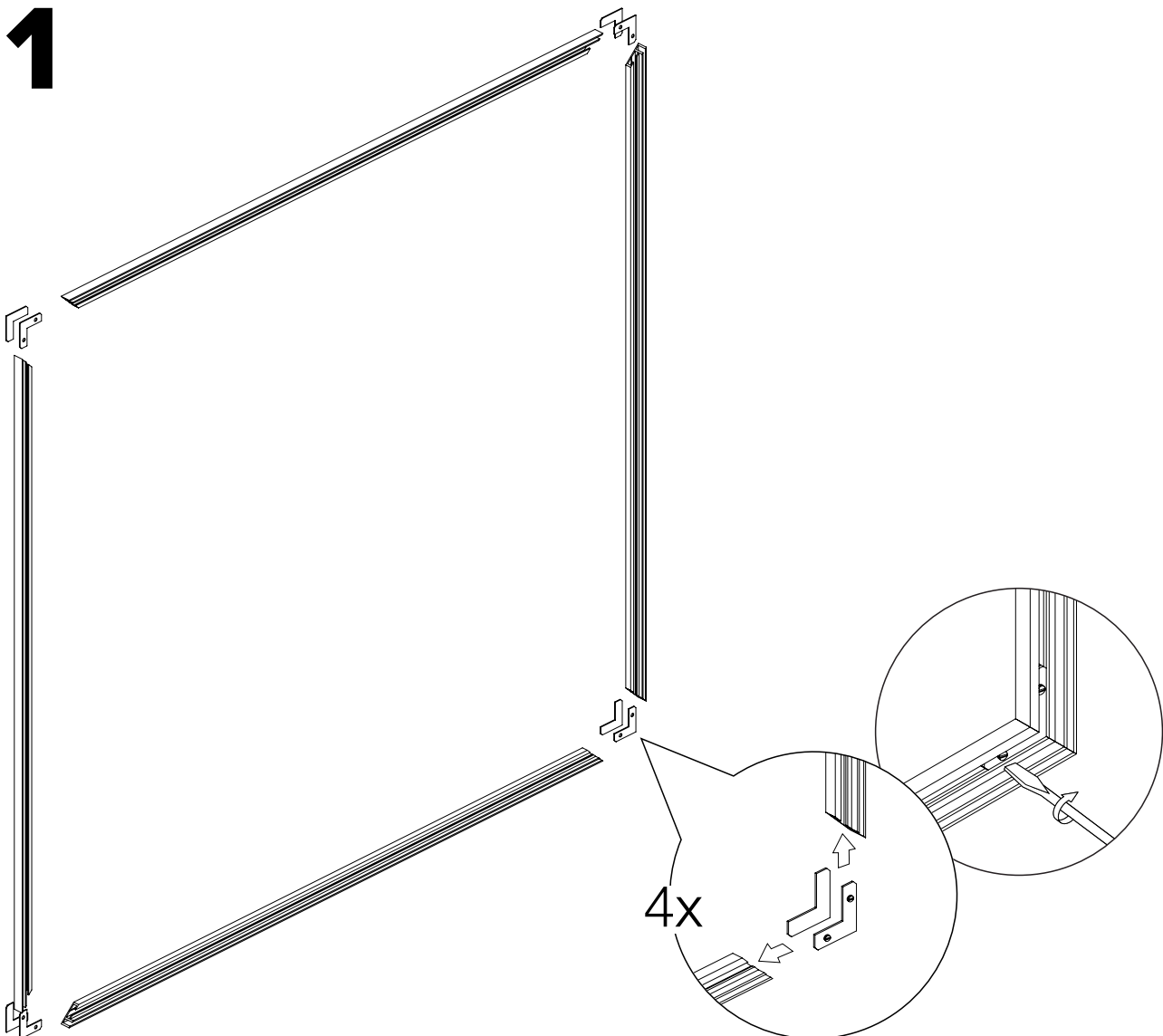

Mounting process

1

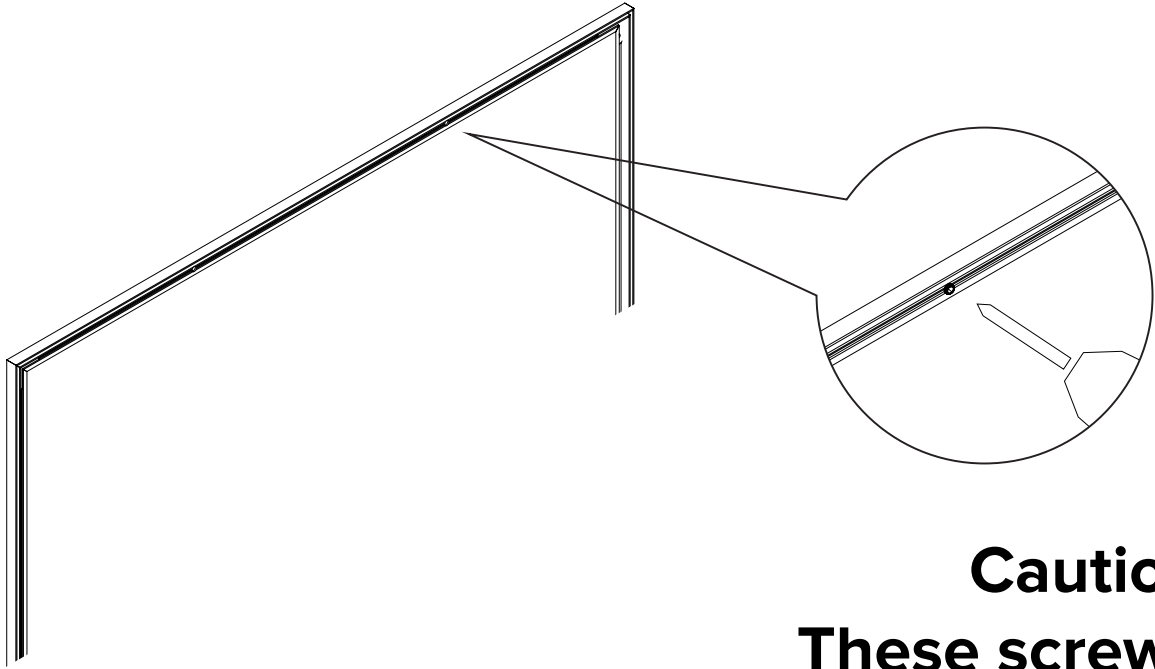

**2**



**Caution**   
**These screws**  
**are not provided** 

**3**

**Banner placement**

